

mece

SISTEMI DI CARICO IN LEGA D'ALLUMINIO

ttai

ALUMINIUM ALLOY LOADING SYSTEMS VERLADESYSTEME AUS ALUMINIUM

meec

PROFESSIONAL LINE 2015/1



RAMPE DA CARICO IN LEGA D'ALLUMINIO
ALUMINIUM ALLOY LOADING RAMPS
VERLADERAMPEN AUS ALUMINIUM



CODICE ITEM CODE PRODUKTCODE	PAGINA PAGE SEITE
M030	3
M040	4
M050	5
M070-M075-M080	6
M100	7
M115A-M125	8
M140-M150	9
M165	10
M170-M185	11
M200-M230	12
M120S rivestimento in gomma <i>rubber-covering Gummi-Beschichtung</i>	13. 14
M120S rivestimento in lamiera <i>aluminium sheet covering Blech-Beschichtung</i>	15. 16
Passerelle carrali, pedonali, pedane di carico, pedane M070P <i>Gangways (driveways, walkways) event & removal ramps, M070P skip ramps Ladebruecke (Fahr-/Laufbrücke) Event-Schiene, M070P Mistrampen</i>	17. 18
Rampe SH / Rampe speciali <i>SH short ramps / special ramps SH rampen / Sonderrampen</i>	19
Accessori-Opzioni / Testate-appoggi <i>Accessories-Options / Head connections Zubehöre-Optionen / Auflageköpfe</i>	20
Norme di sicurezza rampe di carico Note <i>safety standards aluminium ramps - remarks Sicherheitsrichtlinie Auffahrampen - Bemerkungen</i>	21

PONTI DI CARICO
LOADING BRIDGES
ÜBERLADEBRÜCKE

MBAP-MBAC	22
MPL	23
MS030	24
MS030-2TL	25
avvertenze d'uso serie MBAP MBAC - MPL - MS030 - MS030 2TL <i>instructions for use ranges MBAP MBAC - MPL - MS030 - MS030 2TL Gebrauchsanweisungen serien MBAP MBAC - MPL - MS030 - MS030 2TL</i>	26



Metalmecc,



una professionalità

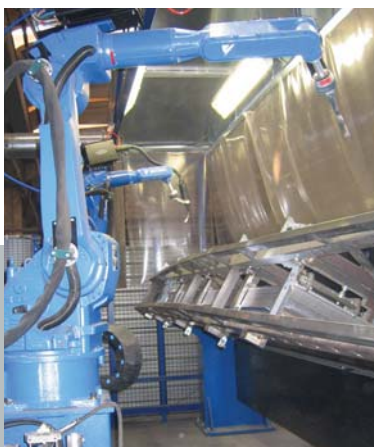

che si evolve



con una costante



ricerca di qualità

RAMPE DA CARICO IN LEGA D'ALLUMINIO

METALMEC, azienda leader sul mercato italiano ed europeo nella produzione di rampe da carico in alluminio, offre ad una clientela sempre più numerosa ed esigente un prodotto altamente **AFFIDABILE** e di indiscussa **QUALITÀ**, grazie a un'esperienza decennale e a una manodopera altamente specializzata.

L'utilizzo della migliore lega di alluminio (tipo 6005A), la **DURATA** e **ROBUSTEZZA** delle rampe, la certificazione TUV di tutti i processi produttivi secondo le norme UNI EN ISO 9001:2008 e dei processi di saldatura secondo le norme EN ISO 15614-2 e EN ISO 15613, oltre al collaudo delle rampe al doppio della portata dichiarata, hanno fatto di METALMEC un'azienda leader anche per serietà.

All'alta qualità della produzione si affianca elevata affidabilità e competenza al servizio dei clienti, ai quali METALMEC garantisce rapidità di risposta alle più svariate richieste, celerità nelle spedizioni e ampia disponibilità per la realizzazione di rampe speciali.

**QUALITÀ E SERIETÀ FANNO LA DIFFERENZA.
QUALITÀ E SERIETÀ SONO LA NOSTRA FORZA.**



ALUMINIUM ALLOY LOADING RAMPS

Metalmec is a leading company in the production of Aluminium loading ramps in both the Italian and European market. Thanks to its long experience over many years in the production of high quality Aluminium products manufactured by a highly qualified workforce, the Company is able to offer a highly reliable product whose quality is widely appreciated worldwide.

Only the very best quality Aluminium (type 6005A) is used which is a guarantee for solid, strong, durable ramps. All production processes are certified by TUV Institute according to Regulations UNI EN ISO 9001:2008 and the same applies for all welding processes which comply to EN ISO 15614-2 and EN ISO 15613 Regulations. In addition to this, every ramp is tested to a loading capacity which is double to the one declared (security coefficient=2). This is a further guarantee of reliability.

An efficient customer service complements high production quality with a prompt response to our customers' differing enquiries. Quick shipment of goods and an ability to manufacture special ramps on request make Metalmec the foremost name in high quality light-weight Aluminium loading ramps.

**QUALITY AND RELIABILITY MAKE THE DIFFERENCE.
QUALITY AND RELIABILITY ARE OUR STRENGTH.**

VERLADERAMPEN AUS ALUMINIUM

Metalmec ist ein führendes Unternehmen in der Produktion von Alu-Rampen, sowohl auf dem europäischen, als auch auf dem italienischen Markt.

Dank unserer jahrelangen Erfahrung, und dem hoch qualifiziertem Personal, ist unser Unternehmen in der Lage sehr zuverlässige Produkte anzubieten, deren Qualität überall geschätzt wird.

Wir nutzen hochwertiges Aluminium (Typ 6005A), dies garantiert solide stabile und haltbare Rampen.

Alle unser Produktionsabläufe sind zertifiziert gem. den TÜV Richtlinien UNI EN ISO 9001:2008, das gleiche gilt für unser Schweißanlagen (EN ISO 15614-2 und EN ISO 15613).

Zusätzlich sind unsere Rampen für eine doppelte Belastung, als ausgeschrieben (Sicherheits-Koeffizient 2) ausgelegt – eine Garantie für Haltbarkeit.

Neben der hohen Produktqualität, möchten wir auch unseren effizienten Kundenservice erwähnen, unsere schnellen Reaktionen auf verschiedensten Kundenwünsche, kurze Lieferzeiten. Desweiteren können wir auf Anfrage Spezialrampen nach individuellen Vorgaben fertigen.

**QUALITÄT UND ZUVERLÄSSIGKEIT SIND UNSERES KENNZEICHEN !
QUALITÄT UND ZUVERLÄSSIGKEIT SIND UNSERE STÄRKE!**



LE NOSTRE CERTIFICAZIONI



Certificazione sistema gestione qualità
Quality Management System
Qualitätsmanagement-System
ISO 9001:2008



Certificazione di prodotto
Product certification
Produktzertifizierung

Gamme/Ranges/Serien:
M030 - M040 - M050 - M070 - M070P - M075
M080 - M100 - M115A - M120S - M125 - M140
M150 - M165 - M170 - M185 - M200 - M230
SH - MP - MPP - MPC





M030

RAMPE DA CARICO IN LEGA D'ALLUMINIO
ALUMINIUM ALLOY LOADING RAMPS
VERLADERAMPEN AUS ALUMINIUM

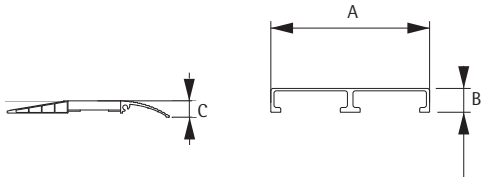
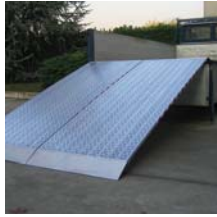

Codice articolo Item code Produktcode	Portata alla coppia kg Loading capacity per pair kg Belastungsfähigkeit pro Paar kg			Lunghezza mm Length mm Länge mm	Larghezza est. mm External width mm Aussenbreite mm	Altezza montante mm Height of ramps' profile mm Trägerhöhe mm	Ingombro rampa in alt. mm Height of ramp mm Laderamperhöhe mm	Peso alla coppia kg Weight for pair kg Gewicht pro Paar kg
	Passo-Wheelbase Achsenabstand							
	500 mm	750 mm	1000 mm		A	B	C	
M030B2/15	830	1107	1580	1500	215	30	55	13
M030B2/20	553	664	830	2000	215	30	55	16
M030B2/25	415	474	553	2500	215	30	55	19
M030B2/30	315	350	394	3000	215	30	55	23
M030B2/35	249	271	298	3500	215	30	55	26
M030B2/40	201	216	235	4000	215	30	55	29
M030B2/15/2	1660	2214	2900	1500	415	30	55	24
M030B2/20/2	1106	1328	1660	2000	415	30	55	30
M030B2/25/2	830	948	1106	2500	415	30	55	37
M030B2/30/2	630	701	788	3000	415	30	55	44
M030B2/35/2	498	543	597	3500	415	30	55	50
M030B2/40/2	402	433	470	4000	415	30	55	57
M030B3/15	1178	1570	2355	1500	315	30	55	18
M030B3/20	785	942	1178	2000	315	30	55	23
M030B3/25	589	673	785	2500	315	30	55	28
M030B3/30	447	496	559	3000	315	30	55	33
M030B3/35	353	385	423	3500	315	30	55	38
M030B3/40	285	307	334	4000	315	30	55	43
M030B3/15/2	2356	2900	2900	1500	615	30	55	35
M030B3/20/2	1570	1884	2356	2000	615	30	55	45
M030B3/25/2	1178	1346	1570	2500	615	30	55	55
M030B3/30/2	894	993	1119	3000	615	30	55	65
M030B3/35/2	707	770	847	3500	615	30	55	75
M030B3/40/2	571	615	668	4000	615	30	55	85



Incnerimento opzionale.
Il peso indicato non comprende l'incnerimento.
Optional foldable version.
Weight does not include hinges.
Faltbare Rampe auf Anfrage.
Das Gewicht ist nicht einschließlich der Scharniere.

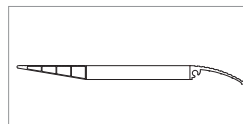

Rampa con coda C040F opzionale.
Ramp with bottom end type F optional.
Rampe mit gedrehtem End-Teil Typ F auf Anfrage.

L'incnerimento riduce la portata a kg 300 per tutti i modelli M030B2 - M040B2 e M050 e a kg 500 per tutti i modelli M030B3 - M040B3. Gamma disponibile solo SENZA BORDO.
The foldable version reduces the ramp loading capacity to 300 kgs on models M030B2 - M040B2 - M050 and to 500 kgs on models M030B3 - M040B3. Range only available WITHOUT EDGES.
Die faltbare-Version verringert die Belastungsfähigkeit pro Paar bis zu 300 kg bei Modellen M030B2 - M040B2 - M050 und bis zu 500 kg bei Modellen M030B3 - M040B3. Rampenserie nur OHNE RAND verfügbar.

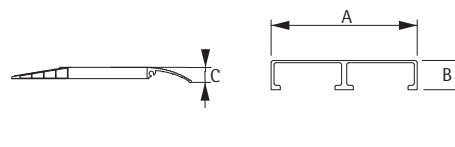

Codice articolo Item code Produktcode	Portata alla coppia kg Loading capacity per pair kg Belastungsfähigkeit pro Paar kg			Lunghezza mm Length mm Länge mm	Larghezza est. mm External width mm Aussenbreite mm	Altezza montante mm Height of ramps' profile mm Trägerhöhe mm	Ingombro rampa in alt. mm Height of ramp mm Laderampenhöhe mm	Peso alla coppia kg Weight for pair kg Gewicht pro Paar kg
	Passo-Wheelbase Achsenabstand							
	500 mm	750 mm	1000 mm		A	B	C	
M040B2/15	1259	1580	1580	1500	215	40	55	14
M040B2/20	839	1007	1259	2000	215	40	55	18
M040B2/25	630	719	839	2500	215	40	55	22
M040B2/30	478	532	598	3000	215	40	55	25
M040B2/35	378	412	453	3500	215	40	55	29
M040B2/40	306	328	357	4000	215	40	55	33
M040B2/15/2	2518	2900	2900	1500	415	40	55	26
M040B2/20/2	1678	2014	2518	2000	415	40	55	33
M040B2/25/2	1260	1438	1678	2500	415	40	55	41
M040B2/30/2	957	1064	1197	3000	415	40	55	48
M040B2/35/2	756	824	907	3500	415	40	55	56
M040B2/40/2	612	657	714	4000	415	40	55	63
M040B3/15	2132	2370	2370	1500	315	40	55	21
M040B3/20	1421	1705	2132	2000	315	40	55	27
M040B3/25	1066	1218	1421	2500	315	40	55	33
M040B3/30	810	899	1012	3000	315	40	55	39
M040B3/35	639	697	767	3500	315	40	55	45
M040B3/40	517	557	604	4000	315	40	55	51
M040B3/15/2	2900	2900	2900	1500	615	40	55	40
M040B3/20/2	2842	2900	2900	2000	615	40	55	52
M040B3/25/2	2132	2436	2842	2500	615	40	55	64
M040B3/30/2	1620	1799	2025	3000	615	40	55	76
M040B3/35/2	1279	1395	1535	3500	615	40	55	88
M040B3/40/2	1035	1115	1208	4000	615	40	55	100



Incernieramento opzionale.
Il peso indicato non comprende l'incernieramento.
Optional foldable version.
Weight does not include hinges.
Faltbare Rampe auf Anfrage.
Das Gewicht ist nicht einschließlich der Scharniere.

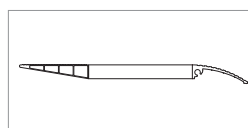

Rampa con coda C040F opzionale.
Ramp with bottom end type F optional.
Rampe mit gedrehtem End-Teil Typ F auf Anfrage.

L'incernieramento riduce la portata a kg 300 per tutti i modelli M030B2 - M040B2 e M050 e a kg 500 per tutti i modelli M030B3 - M040B3. Gamma disponibile solo SENZA BORDO.
The foldable version reduces the ramp loading capacity to 300 kgs on models M030B2 - M040B2 - M050 and to 500 kgs on models M030B3 - M040B3. Range only available WITHOUT EDGES.
Die faltbare-Version verringert die Belastungsfähigkeit pro Paar bis zu 300 kg bei Modellen M030B2 - M040B2 - M050 und bis zu 500 kg bei Modellen M030B3 - M040B3. Rampenserie nur OHNE RAND verfügbar.



M050

RAMPE DA CARICO IN LEGA D'ALLUMINIO
ALUMINIUM ALLOY LOADING RAMPS
VERLADERAMPEN AUS ALUMINIUM

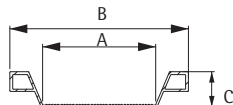
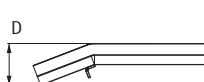

Codice articolo Item code Produktcode	Portata alla coppia kg Loading capacity per pair kg Belastungsfähigkeit pro Paar kg			Lunghezza mm Length mm Länge mm	Larghezza int. mm Internal width mm Innenbreite mm	Larghezza est. mm External width mm Aussenbreite mm	Altezza bordo mm Height of raised edge mm Randhöhe mm	Ingombro tot. rampa mm Total ramps' encombance mm Gesamthöhe der Rampe mm	Peso alla coppia kg Weight for pair kg Gewicht pro Paar kg
	Passo-Wheelbase Achsenabstand			A	B	C	D		
	0 mm	500 mm	1000 mm						
M050/10	800	1500	1500	1000	155	246	45	100	9
M050/15	800	1479	1500	1500	155	246	45	100	13
M050/20	739	986	1479	2000	155	246	45	100	17
M050/25	532	665	887	2500	155	246	45	100	20
M050/30	419	503	628	3000	155	246	45	100	24
M050/35	346	404	485	3500	155	246	45	100	28



Innesto a baionetta per rampe in più parti (applicabile a richiesta e con sovrapprezzo).

Bayonet connection for ramps in several parts (special device on request and with additional price, only on range M050)

Bajonetverschluss für mehrteilige Rampen (Sonderfertigung auf Anfrage und mit Mehrpreis nur für Serie M050)



Incernieramento opzionale.
Il peso indicato non comprende l'incernieramento.
Optional foldable version.
Weight does not include hinges.
Faltbare Rampe auf Anfrage.
Das Gewicht ist nicht einschließlich der Scharniere.

L'incernieramento riduce la portata a kg 300 per tutti i modelli M030B2 - M040B2 e M050 e a kg 500 per tutti i modelli M030B3 - M040B3.
Gamma disponibile solo CON BORDO.

The foldable version reduces the ramp loading capacity to 300 kgs on models M030B2 - M040B2 - M050 and to 500 kgs on models M030B3 - M040B3.
Range only available WITH EDGES.

Die faltbare-Version verringert die Belastungsfähigkeit pro Paar bis zu 300 kg bei Modellen M030B2 - M040B2 - M050 und bis zu 500 kg bei Modellen M030B3 - M040B3.
Rampenserie nur MIT RAND verfügbar.

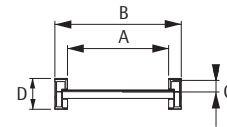
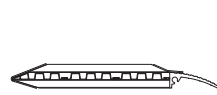

Codice articolo Item code Produktcode	Portata alla coppia kg Loading capacity per pair kg Belastungsfähigkeit pro Paar kg			Lunghezza mm Length mm Länge mm	Larghezza int. mm Internal width mm Innenbreite mm	Larghezza est. mm External width mm Aussenbreite mm	Altezza bordo mm Height of raised edge mm Randhöhe mm	Altezza montante mm Height of ramps' profile mm Trägerhöhe mm	Peso alla coppia kg Weight for pair kg Gewicht pro Paar kg
	Passo-Wheelbase Achsenabstand								
	750 mm	1000 mm	1250 mm		A	B	C	D	
M070/15	2500	2750	3000	1500	240	300	23	70	19
M070/20	1525	1906	2500	2000	240	300	23	70	24
M070/25	1090	1270	1525	2500	240	300	23	70	28
M070/30	850	960	1085	3000	240	300	23	70	34
M070/35	700	765	845	3500	240	300	23	70	39
M070/40	597	647	706	4000	240	300	23	70	43

Larghezza minima impronta ruota/cingolo 150 mm. Minimum width of tracks/wheels 150 mm. Mindestbreite der Reifen / Ketten mm 150.

M070/15L	2450	2450	2450	1500	440	500	23	70	26
M070/20L	1525	1906	2450	2000	440	500	23	70	32
M070/25L	1090	1270	1525	2500	440	500	23	70	38
M070/30L	850	960	1085	3000	440	500	23	70	46
M070/35L	700	765	845	3500	440	500	23	70	52
M070/40L	597	647	706	4000	440	500	23	70	58

Larghezza minima impronta ruota/cingolo 300 mm. Minimum width of tracks/wheels 300 mm. Mindestbreite der Reifen / Ketten mm 300.

	1000 mm	1250 mm	1500 mm						
M075/20	3200	3500	3500	2000	240	300	19	75	32
M075/25	2150	2600	3200	2500	240	300	19	75	39
M075/30	1600	1850	2150	3000	240	300	19	75	43
M075/35	1300	1450	1600	3500	240	300	19	75	49
M075/40	1100	1150	1300	4000	240	300	19	75	54
M075/45	900	1000	1050	4500	240	300	19	75	62

Larghezza minima impronta ruota/cingolo 150 mm. Minimum width of tracks/wheels 150 mm. Mindestbreite der Reifen / Ketten mm 150.

	1000 mm	1250 mm	1500 mm						
M080/20	2510	3000	3000	2000	240	300	23	80	26
M080/25	1674	2009	2510	2500	240	300	23	80	31
M080/30	1255	1435	1674	3000	240	300	23	80	38
M080/35	1004	1116	1255	3500	240	300	23	80	43
M080/40	837	913	1004	4000	240	300	23	80	48
M080/45	717	772	837	4500	240	300	23	80	55

Larghezza minima impronta ruota/cingolo 150 mm. Minimum width of tracks/wheels 150 mm. Mindestbreite der Reifen / Ketten mm 150.

Gamma disponibile CON o SENZA BORDO.
Range available both WITH or WITHOUT EDGES.
Rampenserie MIT oder OHNE RAND verfügbar.



M100

RAMPE DA CARICO IN LEGA D'ALLUMINIO
ALUMINIUM ALLOY LOADING RAMPS
VERLADERAMPEN AUS ALUMINIUM

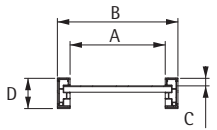

Codice articolo Item code Produktcode	Portata alla coppia kg Loading capacity per pair kg Belastungsfähigkeit pro Paar kg	Lunghezza mm Length mm Länge mm	Larghezza int. mm Internal width mm Innenbreite mm	Larghezza est. mm External width mm Aussenbreite mm	Altezza bordo mm Height of raised edge mm Randhöhe mm	Altezza montante mm Height of ramps' profile mm Tragerhöhe mm	Peso alla coppia kg Weight for pair kg Gewicht pro Paar kg
	Passo-Wheelbase Achsenabstand		A	B	C	D	
	1000 mm 1250 mm 1500 mm						
M100/25	2330 2800 3500	2500	300	360	23	100	40
M100/30	1750 2000 2330	3000	300	360	23	100	42
M100/35	1400 1550 1750	3500	300	360	23	100	48
M100/40	1165 1270 1400	4000	300	360	23	100	53
M100/45	1000 1075 1165	4500	300	360	23	100	61
M100/50	875 930 1000	5000	300	360	23	100	66

Larghezza minima impronta ruota/cingolo 200 mm. Minimum width of tracks/wheels 200 mm. Mindestbreite der Reifen / Ketten mm 200.

M100/25L	2330 2800 3500	2500	340	400	23	100	43
M100/30L	1750 2000 2330	3000	340	400	23	100	52
M100/35L	1400 1550 1750	3500	340	400	23	100	51
M100/40L	1165 1270 1400	4000	340	400	23	100	56
M100/45L	1000 1075 1165	4500	340	400	23	100	64
M100/50L	875 930 1000	5000	340	400	23	100	70

Larghezza minima impronta ruota/cingolo 300 mm. Minimum width of tracks/wheels 300 mm. Mindestbreite der Reifen / Ketten mm 300.

Gamma disponibile CON o SENZA BORDO.
Range available both WITH or WITHOUT EDGES.
Rampenserie MIT oder OHNE RAND verfügbar.

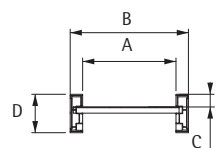
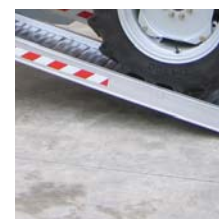

Codice articolo Item code Produktcode	Portata alla coppia kg Loading capacity per pair kg Belastungsfähigkeit pro Paar kg			Lunghezza mm Length mm Länge mm	Larghezza int. mm internal width mm Innenbreite mm	Larghezza est. mm External width mm Aussenbreite mm	Altezza bordo mm Height of raised edge mm Randhöhe mm	Altezza montante mm Height of ramps' profile mm Trägerhöhe mm	Peso alla coppia kg Weight for pair kg Gewicht pro Paar kg
	Passo-Wheelbase Achsenabstand								
	1000 mm	1250 mm	1500 mm		A	B	C	D	
M115A/25	3000	3600	4000	2500	300	360	36	115	42
M115A/30	2250	2570	3000	3000	300	360	36	115	45
M115A/35	1800	2000	2250	3500	300	360	36	115	51
M115A/40	1500	1635	1800	4000	300	360	36	115	57
M115A/45	1285	1385	1500	4500	300	360	36	115	65
M115A/50	1125	1200	1285	5000	300	360	36	115	70

Larghezza minima impronta ruota/cingolo 200 mm. Minimum width of tracks/wheels 200 mm. Mindestbreite der Reifen / Ketten mm 200.

M115A/25L	3000	3600	4000	2500	340	400	36	115	45
M115A/30L	2250	2570	3000	3000	340	400	36	115	54
M115A/35L	1800	2000	2250	3500	340	400	36	115	62
M115A/40L	1500	1635	1800	4000	340	400	36	115	69
M115A/45L	1285	1385	1500	4500	340	400	36	115	78
M115A/50L	1125	1200	1285	5000	340	400	36	115	86

Larghezza minima impronta ruota/cingolo 300 mm. Minimum width of tracks/wheels 300 mm. Mindestbreite der Reifen / Ketten mm 300.

M125/25	4500	4500	4500	2500	300	360	36	125	47
M125/30	3435	3925	4500	3000	300	360	36	125	58
M125/35	2750	3050	3435	3500	300	360	36	125	66
M125/40	2290	2500	2750	4000	300	360	36	125	73
M125/45	1965	2115	2290	4500	300	360	36	125	84
M125/50	1720	1830	1965	5000	300	360	36	125	92

Larghezza minima impronta ruota/cingolo 200 mm. Minimum width of tracks/wheels 200 mm. Mindestbreite der Reifen / Ketten mm 200.

M125/25L	4500	4500	4500	2500	340	400	36	125	50
M125/30L	3435	3925	4500	3000	340	400	36	125	61
M125/35L	2750	3050	3435	3500	340	400	36	125	69
M125/40L	2290	2500	2750	4000	340	400	36	125	78
M125/45L	1965	2115	2290	4500	340	400	36	125	89
M125/50L	1720	1830	1965	5000	340	400	36	125	97

Larghezza minima impronta ruota/cingolo 300 mm. Minimum width of tracks/wheels 300 mm. Mindestbreite der Reifen / Ketten mm 300.

Gamma disponibile CON o SENZA BORDO.
Range available both WITH or WITHOUT EDGES.
Rampenserie MIT oder OHNE RAND verfügbar.



M140-M150

RAMPE DA CARICO IN LEGA D'ALLUMINIO
ALUMINIUM ALLOY LOADING RAMPS
VERLADERAMPEN AUS ALUMINIUM

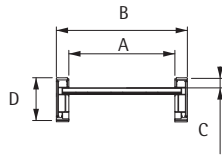
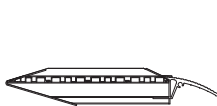

Codice articolo Item code Produktcode	Portata alla coppia kg Loading capacity per pair kg Belastungsfähigkeit pro Paar kg	Lunghezza mm Length mm Länge mm	Larghezza int. mm Internal width mm Innenbreite mm	Larghezza est. mm External width mm Aussenbreite mm	Altezza bordo mm Height of raised edge mm Randhöhe mm	Altezza montante mm Height of ramps' profile mm Trägerhöhe mm	Peso alla coppia kg Weight for pair kg Gewicht pro Paar kg
	Passo-Wheelbase Achsenabstand		A	B	C	D	
	1000 mm 1250 mm 1500 mm						
M140/25	5500 5500 5500	2500	340	400	32	140	57
M140/30	4155 4750 5500	3000	340	400	32	140	69
M140/35	3325 3695 4155	3500	340	400	32	140	76
M140/40	2770 3025 3325	4000	340	400	32	140	85
M140/45	2375 2560 2770	4500	340	400	32	140	96
M140/50	2080 2215 2375	5000	340	400	32	140	105

Larghezza minima impronta ruota/cingolo 300 mm. Minimum width of tracks/wheels 300 mm. Mindestbreite der Reifen / Ketten mm 300.

M140/25L	5000 5000 5000	2500	420	480	32	140	63
M140/30L	4155 4750 5000	3000	420	480	32	140	77
M140/35L	3325 3695 4155	3500	420	480	32	140	87
M140/40L	2770 3025 3325	4000	420	480	32	140	98
M140/45L	2375 2560 2770	4500	420	480	32	140	111
M140/50L	2080 2215 2375	5000	420	480	32	140	122

Larghezza minima impronta ruota/cingolo 350 mm. Minimum width of tracks/wheels 350 mm. Mindestbreite der Reifen / Ketten mm 350.

Codice articolo Item code Produktcode	Portata alla coppia kg Loading capacity per pair kg Belastungsfähigkeit pro Paar kg	Lunghezza mm Length mm Länge mm	Larghezza int. mm Internal width mm Innenbreite mm	Larghezza est. mm External width mm Aussenbreite mm	Altezza bordo mm Height of raised edge mm Randhöhe mm	Altezza montante mm Height of ramps' profile mm Trägerhöhe mm	Peso alla coppia kg Weight for pair kg Gewicht pro Paar kg
	Passo-Wheelbase Achsenabstand		A	B	C	D	
	1250 mm 1500 mm 1750 mm						
M150/25	6000 6000 6000	2500	340	400	32	150	61
M150/30	5890 6000 6000	3000	340	400	32	150	74
M150/35	4580 5150 5890	3500	340	400	32	150	84
M150/40	3745 4120 4580	4000	340	400	32	150	91
M150/45	3170 3435 3745	4500	340	400	32	150	103
M150/50	2750 2945 3170	5000	340	400	32	150	116

Larghezza minima impronta ruota/cingolo 300 mm. Minimum width of tracks/wheels 300 mm. Mindestbreite der Reifen / Ketten mm 300.

Gamma disponibile CON o SENZA BORDO.
Range available both WITH or WITHOUT EDGES.
Rampenserie MIT oder OHNE RAND verfügbar.

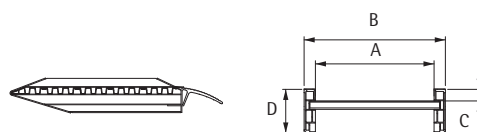

Codice articolo Item code Produktcode	Portata alla coppia kg Loading capacity per pair kg Belastungsfähigkeit pro Paar kg	Lunghezza mm Length mm Länge mm	Larghezza int. mm Internal width mm Innenbreite mm	Larghezza est. mm External width mm Aussenbreite mm	Altezza bordo mm Height of raised edge mm Randhöhe mm	Altezza montante mm Height of ramps' profile mm Tragerhöhe mm	Peso alla coppia kg Weight for pair kg Gewicht pro Paar kg
---	---	---------------------------------------	--	---	---	---	--

Passo-Wheelbase
Achsenabstand

	1250 mm	1500 mm	1750 mm	A	B	C	D		
M165/25	6385	6385	6385	2500	420	480	43	165	74
M165/30	6385	6385	6385	3000	420	480	43	165	91
M165/35	5620	6325	6385	3500	420	480	43	165	103
M165/40	4600	5060	5620	4000	420	480	43	165	114
M165/45	3890	4215	4600	4500	420	480	43	165	130
M165/50	3375	3615	3890	5000	420	480	43	165	142

Larghezza minima impronta ruota/cingolo 350 mm. Minimum width of tracks/wheels 350 mm. Mindestbreite der Reifen / Ketten mm 350.

M165/25L	6385	6385	6385	2500	450	510	43	165	76
M165/30L	6385	6385	6385	3000	450	510	43	165	93
M165/35L	5620	6325	6385	3500	450	510	43	165	105
M165/40L	4600	5060	5620	4000	450	510	43	165	118
M165/45L	3890	4215	4600	4500	450	510	43	165	135
M165/50L	3375	3615	3890	5000	450	510	43	165	147

Larghezza minima impronta ruota/cingolo 400 mm. Minimum width of tracks/wheels 400 mm. Mindestbreite der Reifen / Ketten mm 400.

Gamma disponibile CON o SENZA BORDO.

Range available both WITH or WITHOUT EDGES.

Rampenserie MIT oder OHNE RAND verfügbar.



M170-M185

RAMPE DA CARICO IN LEGA D'ALLUMINIO
ALUMINIUM ALLOY LOADING RAMPS
VERLADERAMPEN AUS ALUMINIUM

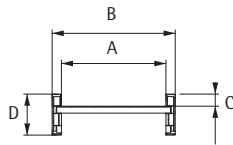
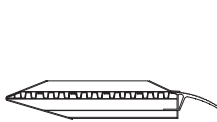

Codice articolo Item code Produktcode	Portata alla coppia kg Loading capacity per pair kg Belastungsfähigkeit pro Paar kg			Lunghezza mm Length mm Länge mm	Larghezza int. mm internal width mm Innenbreite mm	Larghezza est. mm External width mm Ausßenbreite mm	Altezza bordo mm Height of raised edge mm Randhöhe mm	Altezza montante mm Height of ramps' profile mm Tragerhöhe mm	Peso alla coppia kg Weight for pair kg Gewicht pro Paar kg
	Passo-Wheelbase Achsenabstand			A	B	C	D		
	1500 mm	1750 mm	2000 mm						
M170/25	8300	8300	8300	2500	450	530	50	170	84
M170/30	8300	8300	8300	3000	450	530	50	170	103
M170/35	7182	8209	8300	3500	450	530	50	170	118
M170/40	5745	6385	6385	4000	450	530	50	170	127
M170/45	4788	5254	5745	4500	450	530	50	170	144
M170/50	4104	4420	4788	5000	450	530	50	170	157
M170/55	3591	3830	4104	5500	450	530	50	170	170

Larghezza minima impronta ruota/cingolo 400 mm. Minimum width of tracks/wheels 400 mm. Mindestbreite der Reifen / Ketten mm 400.

Codice articolo Item code Produktcode	Portata alla coppia kg Loading capacity per pair kg Belastungsfähigkeit pro Paar kg			Lunghezza mm Length mm Länge mm	Larghezza int. mm internal width mm Innenbreite mm	Larghezza est. mm External width mm Ausßenbreite mm	Altezza bordo mm Height of raised edge mm Randhöhe mm	Altezza montante mm Height of ramps' profile mm Tragerhöhe mm	Peso alla coppia kg Weight for pair kg Gewicht pro Paar kg
	Passo-Wheelbase Achsenabstand			A	B	C	D		
	1500 mm	1750 mm	2000 mm						
M185/25	10000	10000	10000	2500	450	530	57	185	100
M185/30	10000	10000	10000	3000	450	530	57	185	120
M185/35	8876	10000	10000	3500	450	530	57	185	136
M185/40	7100	7889	8876	4000	450	530	57	185	148
M185/45	5917	6455	7100	4500	450	530	57	185	160
M185/50	5072	5462	5917	5000	450	530	57	185	175
M185/55	4438	4733	5072	5500	450	530	57	185	190

Larghezza minima impronta ruota/cingolo 400 mm. Minimum width of tracks/wheels 400 mm. Mindestbreite der Reifen / Ketten mm 400.

Gamma disponibile CON o SENZA BORDO.
Range available both WITH or WITHOUT EDGES.
Rampenserie MIT oder OHNE RAND verfügbar.

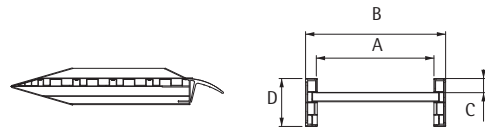

Codice articolo Item code Produktcode	Portata alla coppia kg Loading capacity per pair kg Belastungsfähigkeit pro Paar kg			Lunghezza mm Length mm Länge mm	Larghezza int. mm internal width mm Innenbreite mm	Larghezza est. mm External width mm Aussenbreite mm	Altezza bordo mm Height of raised edge mm Randhöhe mm	Altezza montante mm Height of ramps' profile mm Tragerhöhe mm	Peso alla coppia kg Weight for pair kg Gewicht pro Paar kg
	Passo-Wheelbase Achsenabstand			A	B	C	D		
	1500 mm	1750 mm	2000 mm						
M200/25	12000	12000	12000	2500	500	600	57	200	112
M200/30	12000	12000	12000	3000	500	600	57	200	137
M200/35	10625	12000	12000	3500	500	600	57	200	156
M200/40	8500	9445	10625	4000	500	600	57	200	174
M200/45	7085	7730	8500	4500	500	600	57	200	198
M200/50	6070	6540	7085	5000	500	600	57	200	206
M200/55	5310	5665	6070	5500	500	600	57	200	223

Larghezza minima impronta ruota/cingolo 450 mm. Minimum width of tracks/wheels 450 mm. Mindestbreite der Reifen / Ketten mm 450.

Codice articolo Item code Produktcode	Portata alla coppia kg Loading capacity per pair kg Belastungsfähigkeit pro Paar kg			Lunghezza mm Length mm Länge mm	Larghezza int. mm internal width mm Innenbreite mm	Larghezza est. mm External width mm Aussenbreite mm	Altezza bordo mm Height of raised edge mm Randhöhe mm	Altezza montante mm Height of ramps' profile mm Tragerhöhe mm	Peso alla coppia kg Weight for pair kg Gewicht pro Paar kg
	Passo-Wheelbase Achsenabstand			A	B	C	D		
	1500 mm	1750 mm	2000 mm						
M230/25	14000	14000	14000	2500	500	600	71	230	123
M230/30	14000	14000	14000	3000	500	600	71	230	150
M230/35	14000	14000	14000	3500	500	600	71	230	171
M230/40	12000	13340	14000	4000	500	600	71	230	191
M230/45	10008	10918	12000	4500	500	600	71	230	219
M230/50	8578	9238	10008	5000	500	600	71	230	239
M230/55	7506	8006	8578	5500	500	600	71	230	260

Larghezza minima impronta ruota/cingolo 450 mm. Minimum width of tracks/wheels 450 mm. Mindestbreite der Reifen / Ketten mm 450.

Gamma disponibile CON o SENZA BORDO.

Range available both WITH or WITHOUT EDGES.

Rampenserie MIT oder OHNE RAND verfügbar.



M120S

RAMPE DA CARICO IN LEGA D'ALLUMINIO
ALUMINIUM ALLOY LOADING RAMPS
VERLADERAMPEN AUS ALUMINIUM

rivestimento in gomma rubber covering Gummi-Beschichtung



Codice articolo Item code Produktcode	Portata alla coppia kg Loading capacity per pair kg Belastungsfähigkeit pro Paar kg			Lunghezza mm Length mm Länge mm	Altezza montante mm Height of ramps' profile mm Tragerhöhe mm	Larghezza totale mm Total width mm Gesamtbreite mm	Peso alla coppia kg Weight for pair kg Gewicht pro Paar kg
	Passo-Wheelbase Achsenabstand						
	1500 mm	1750 mm	2000 mm		A	B	
M120S/2/20 R	11000	11000	11000	2000	130	240	55
M120S/2/25 R	9575	11000	11000	2500	130	240	65
M120S/2/30 R	6383	7660	9575	3000	130	240	76
M120S/2/35 R	4787	5471	6383	3500	130	240	86
M120S/2/40 R	3830	4256	4787	4000	130	240	97
M120S/2/45 R	3192	3482	3830	4500	130	240	108
M120S/2/50 R	2736	2946	3192	5000	130	240	118
M120S/2/55 R	2394	2553	2736	5500	130	240	129
M120S/3/20 R	13200	13200	13200	2000	130	360	78
M120S/3/25 R	13200	13200	13200	2500	130	360	94
M120S/3/30 R	9574	11489	13200	3000	130	360	110
M120S/3/35 R	7181	8207	9574	3500	130	360	126
M120S/3/40 R	5744	6383	7181	4000	130	360	141
M120S/3/45 R	4787	5222	5744	4500	130	360	157
M120S/3/50 R	4103	4419	4787	5000	130	360	173
M120S/3/55 R	3590	3829	4103	5500	130	360	189
M120S/4/20 R	17500	17500	17500	2000	130	480	103
M120S/4/25 R	17500	17500	17500	2500	130	480	125
M120S/4/30 R	12766	15319	17500	3000	130	480	146
M120S/4/35 R	9574	10942	12766	3500	130	480	167
M120S/4/40 R	7659	8511	9574	4000	130	480	188
M120S/4/45 R	6383	6963	7659	4500	130	480	209
M120S/4/50 R	5471	5892	6383	5000	130	480	230
M120S/4/55 R	4787	5106	5471	5500	130	480	257

Gamma disponibile solo SENZA BORDO.
Range only available WITHOUT EDGES.
Rampenserie nur OHNE RAND verfügbar.



rivestimento in gomma *rubber covering* *Gummi-Beschichtung*

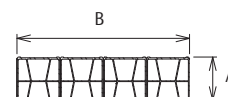
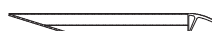

Codice articolo Item code Produktcode	Portata alla coppia kg Loading capacity per pair kg Belastungsfähigkeit pro Paar kg			Lunghezza mm Length Länge mm	Altezza montante mm Height of ramps' profile mm Tragerhöhe mm	Larghezza totale mm Total width mm Gesamtbreite mm	Peso alla coppia kg Weight for pair kg Gewicht pro Paar kg
	Passo-Wheelbase Achsenabstand						
	1500 mm	1750 mm	2000 mm		A	B	
M120S/5/20 R	21700	21700	21700	2000	130	600	129
M120S/5/25 R	21700	21700	21700	2500	130	600	155
M120S/5/30 R	15958	19149	21700	3000	130	600	182
M120S/5/35 R	11968	13678	15958	3500	130	600	208
M120S/5/40 R	9574	10638	11968	4000	130	600	235
M120S/5/45 R	7979	8704	9574	4500	130	600	261
M120S/5/50 R	6839	7365	7979	5000	130	600	288
M120S/5/55 R	5984	6383	6839	5500	130	600	314
M120S/6/20 R	26300	26300	26300	2000	130	720	154
M120S/6/25 R	26300	26300	26300	2500	130	720	186
M120S/6/30 R	19149	22979	26300	3000	130	720	218
M120S/6/35 R	14362	16414	19149	3500	130	720	250
M120S/6/40 R	11489	12766	14362	4000	130	720	281
M120S/6/45 R	9574	10445	11489	4500	130	720	313
M120S/6/50 R	8207	8838	9574	5000	130	720	345
M120S/6/55 R	7181	7659	8207	5500	130	720	377

Gomma più acciaio per mezzi cingolati ferro fissata sulle rampe con delle viti e quindi sostituibile quando usurata. Gamma disponibile solo SENZA BORDO.
Rubber and steel for iron tracked vehicles fixed onto to the ramps with screws and therefore replaceable when worn. Range only available WITHOUT EDGES.
Gummi + Stahl für Stahlkettenfahrzeuge; das Aggregat ist mittels Schrauben an den Rampen befestigt und kann daher bei Verschleiß ersetzt werden. Rampenserie nur OHNE RAND verfügbar.

COME SI DEFINISCE IL CODICE

Il codice deve essere completato prima con la lettera che contraddistingue il tipo di testata ed infine la lettera del tipo di rivestimento.

- G** testata con uncino
- T** testata con tubo
- L** testata standard
- A** testata con appoggio
- R** rivestimento in gomma
- AL** rivestimento in lamiera mandrolata

HOW TO COMPOSE THE CODE

Complete the code by adding the letter identifying the type of head followed by the letter referring to the type of covering.

- G** head with hook
- T** head with tube
- L** standard head
- A** head with support
- R** covering with rubber
- AL** covering with quintet aluminium sheet

WIE MAN DER CODE FORMULIERT

Code mit dem Kennbuchstaben der Kopfart und dann mit dem der Beschichtungsart ergänzen.

- G** Hakenkopf
- T** Endkopf mit Rohr
- L** Standardkopf
- A** Endkopf mit Lager
- R** Gummibeschichtung
- AL** Beschichtung aus Quintetblech

esempio: **M120-3-30 GAL**

↓ ↓ ↓

modello numero di moduli testata ad uncino e rivestimento in lamiera mandrolata

e.g.: **M120-3-30 GAL**

↓ ↓ ↓

model modules head with hook and aluminium sheet covering

Beispiel: **M120-3-30 GAL**

↓ ↓ ↓

model modulen Hakenkopf und Beschichtung aus Quintetblech

Il peso indicato è al netto del peso del rivestimento.
Weight does not include covering.
Das Gewicht ist nicht der Beschichtung einschließl.



M120S

RAMPE DA CARICO IN LEGA D'ALLUMINIO
ALUMINIUM ALLOY LOADING RAMPS
VERLADERAMPEN AUS ALUMINIUM

rivestimento in lamiera aluminium sheet covering Quintettblech-Beschichtung



Codice articolo Item code Produktcode	Portata alla coppia kg Loading capacity per pair kg Belastungsfähigkeit pro Paar kg			Lunghezza mm Length mm Länge mm	Altezza montante mm Height of ramps' profile mm Tragerhöhe mm	Larghezza totale mm Total width mm Gesamtbreite mm	Peso alla coppia kg Weight for pair kg Gewicht pro Paar kg
	Passo-Wheelbase Achsenabstand						
	1500 mm	1750 mm	2000 mm		A	B	
M120S/2/20 AL	11000	11000	11000	2000	130	240	55
M120S/2/25 AL	9575	11000	11000	2500	130	240	65
M120S/2/30 AL	6383	7660	9575	3000	130	240	76
M120S/2/35 AL	4787	5471	6383	3500	130	240	86
M120S/2/40 AL	3830	4256	4787	4000	130	240	97
M120S/2/45 AL	3192	3482	3830	4500	130	240	108
M120S/2/50 AL	2736	2946	3192	5000	130	240	118
M120S/2/55 AL	2394	2553	2736	5500	130	240	129
M120S/3/20 AL	13200	13200	13200	2000	130	360	78
M120S/3/25 AL	13200	13200	13200	2500	130	360	94
M120S/3/30 AL	9574	11489	13200	3000	130	360	110
M120S/3/35 AL	7181	8207	9574	3500	130	360	126
M120S/3/40 AL	5744	6383	7181	4000	130	360	141
M120S/3/45 AL	4787	5222	5744	4500	130	360	157
M120S/3/50 AL	4103	4419	4787	5000	130	360	173
M120S/3/55 AL	3590	3829	4103	5500	130	360	189
M120S/4/20 AL	17500	17500	17500	2000	130	480	103
M120S/4/25 AL	17500	17500	17500	2500	130	480	125
M120S/4/30 AL	12766	15319	17500	3000	130	480	146
M120S/4/35 AL	9574	10942	12766	3500	130	480	167
M120S/4/40 AL	7659	8511	9574	4000	130	480	188
M120S/4/45 AL	6383	6963	7659	4500	130	480	209
M120S/4/50 AL	5471	5892	6383	5000	130	480	230
M120S/4/55 AL	4787	5106	5471	5500	130	480	257

Gamma disponibile solo SENZA BORDO.
Range only available WITHOUT EDGES.
Rampenserie nur OHNE RAND verfügbar.



rivestimento in lamiera aluminium quintet sheet covering Quintettblech-Beschichtung



Codice articolo Item code Produktcode	Portata alla coppia kg Loading capacity per pair kg Belastungsfähigkeit pro Paar kg			Lunghezza mm Length mm Länge mm	Altezza montante mm Height of ramps' profile mm Trägerhöhe mm	Larghezza totale mm Total width mm Gesamtbreite mm	Peso alla coppia kg Weight for pair kg Gewicht pro Paar kg
	Passo-Wheelbase Achsenabstand						
	1500 mm	1750 mm	2000 mm		A	B	
M120S/5/20 AL	21700	21700	21700	2000	130	600	129
M120S/5/25 AL	21700	21700	21700	2500	130	600	155
M120S/5/30 AL	15958	19149	21700	3000	130	600	182
M120S/5/35 AL	11968	13678	15958	3500	130	600	208
M120S/5/40 AL	9574	10638	11968	4000	130	600	235
M120S/5/45 AL	7979	8704	9574	4500	130	600	261
M120S/5/50 AL	6839	7365	7979	5000	130	600	288
M120S/5/55 AL	5984	6383	6839	5500	130	600	314
M120S/6/20 AL	26300	26300	26300	2000	130	720	154
M120S/6/25 AL	26300	26300	26300	2500	130	720	186
M120S/6/30 AL	19149	22979	26300	3000	130	720	218
M120S/6/35 AL	14362	16414	19149	3500	130	720	250
M120S/6/40 AL	11489	12766	14362	4000	130	720	281
M120S/6/45 AL	9574	10445	11489	4500	130	720	313
M120S/6/50 AL	8207	8838	9574	5000	130	720	345
M120S/6/55 AL	7181	7659	8207	5500	130	720	377

Lamiera mandorlata per mezzi gommati, fissata sulle rampe con delle viti e quindi sostituibile quando usurata.

Il peso indicato è al netto del peso del rivestimento. Gamma disponibile solo SENZA BORDO.

Quintet-sheet covering for vehicles with rubber tires or tracks, fixed onto the ramps with screws and therefore replaceable when worn.

Weight does not include covering. Range only available WITHOUT EDGES.

Das Quintettblech für Reifenfahrzeugen oder Gummiketten-Fahrzeugen ist mittels Schrauben an den Rampen befestigt und kann daher bei Verschleiß ersetzt werden. Das Gewicht ist nicht der Beschichtung einschließlich. Rampenserie nur OHNE RAND verfügbar.

passerelle

GANGWAYS
LADEBRÜCKEN

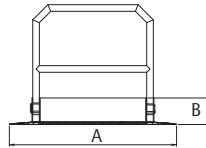
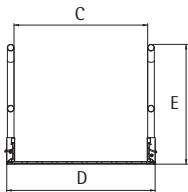

passerelle carrali

DRIVEWAYS
FAHRBRÜCKEN

Codice articolo Item code Produktcode	Portata mezzo cingolato largo 750 mm Load capacity for tracked vehicle width 750 mm Tragfähigkeit bei einem 750 mm breiten Raupenfahrzeug	Portata mezzo gommato largo 900 mm Load cap. for vehicle fitted with rubber tyres width 900 mm Tragfähigkeit bei einem 900 mm breiten Reifenfahrzeug	Lunghezza mm Length mm Länge mm	Alt. battipiede mm Footstaps height Fusshalterhoehe mm	Largh. max. scavo mm Max. width of excavation mm Max.Grubenbreite mm	Largh. interna mm Internal width mm Innenbreite mm	Largh. esterna mm External width mm Aussenbreite mm	Alt. corrimano mm Handrails' height mm Handgelländerhöhe mm	Peso all'unità Kg Weight per piece kg Gewicht pro Stück kg
	Passo - Wheelbase - Achsenabstand		A	B		C	D	E	
	1000 mm	750 mm							
MP12/10	3000	4500	1260	200	600	1000	1120	1000	37
MP12/12	1500	1432	1260	200	600	1250	1370	1000	41
MP16/10	3000	4500	1660	200	1000	1000	1120	1000	47
MP16/12	1500	1432	1660	200	1000	1250	1370	1000	52
MP22/10	3000	4500	2260	200	1600	1000	1120	1000	62
MP22/12	1500	1432	2260	200	1600	1250	1370	1000	70
MP26/10	3000	3514	2660	200	2000	1000	1120	1000	72
MP26/12	1500	1432	2660	200	2000	1250	1370	1000	81
MP32/10	2746	2375	3260	200	2600	1000	1120	1000	87
MP32/12	1500	1432	3260	200	2600	1250	1370	1000	98
MP40/10	1830	1658	4060	200	3400	1000	1120	1000	107
MP40/12	1500	1432	4060	200	3400	1250	1370	1000	121
MP50/10	1292	1204	5060	200	4400	1000	1120	1000	132
MP50/12	1292	1204	5060	200	4400	1250	1370	1000	149
MP60/10	998	945	6060	200	5400	1000	1120	1000	157
MP60/12	998	945	6060	200	5400	1250	1370	1000	178

passerelle pedonali

WALKWAYS
LAUFBRÜCKEN

	Portata - Loading capacity - Tragkraft kg/m ²	A	B		C	D	E	
MPP12/10	400	1260	200	600	1000	1120	1000	34
MPP16/10	400	1660	200	1000	1000	1120	1000	43
MPP22/10	400	2260	200	1600	1000	1120	1000	56
MPP26/10	400	2660	200	2000	1000	1120	1000	64
MPP32/10	400	3260	200	2600	1000	1120	1000	77
MPP40/10	400	4060	200	3400	1000	1120	1000	94
MPP50/10	400	5060	200	4400	1000	1120	1000	115
MPP60/10	400	6060	200	5400	1000	1120	1000	136

Passerelle pedonali e carraie con sponde ripieghevoli per ridurre l'ingombro durante il trasporto. Larghezza minima cingolo 200mm. Impronta minima gomma 200x200 mm. Distribuzione carico sugli assi massima ammessa 40% - 60% (ideale 50% < 50%). **NORME DI UTILIZZO:** la passerella deve avere ad ambo le estremità un appoggio minimo di mm. 330. Le nostre passerelle rispondono ai requisiti dettati dal D.P.R. 547 del 27 aprile 1955 in materia di "fermapiede e corrimano" ed alla legge nr. 13 del 9 gennaio 1989 relativa alle barriere architettoniche. L'inclinazione della passerella non deve superare una pendenza massima del 5%. **Pedestrian walkways and driveways with foldable edges to reduce overall dimensions during transport. Minimum width of iron track 200 mm. Minimum footprint of rubber 200x200 mm. Maximum permitted distribution of load on axles 40%-60% (optimal 50% < 50%). INSTRUCTIONS FOR USE:** at both sides of the walkway there must be a minimum rest of 330 mm. Our walkways are in compliance with the requirements of D.P.R. 547 (April 27th 1955) with regard to "foot stops and handrails" and law No. 13 (January 9th 1989) regarding architectural barriers. The max. gradient of 5% in the gangway's inclination cannot be exceeded. **Trittbare und befahrbare Brücken mit klappbare Seitenwänden zum Raumsparen während des Transports. Mindestbreite der Raupenkette mm 200. Mindestreifenabdruck mm 200x200. Max zulässige Achsenlastverteilung 40% - 60% (optimal 50% / < 50%). GEBRAUCHSANLEITUNGEN:** beide Brückenden sollen Lager von mindestens 330 mm. aufweisen. Unsere Laufstege entsprechen den Forderungen vom Präsidielerlaß Nr.547 vom 27. April 1955 über "Fußhalter und Handgelländer" und dem Gesetz Nr.13 vom 9. Januar 1989 über bauliche Hindernisse. Die max. Steigung der 5% bei der Rampen-Inklination darf nicht überschritten werden.



pedane di carico

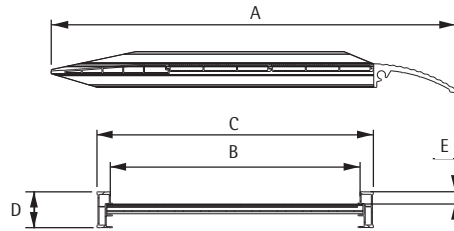

Codice articolo Item code Produktcode	Portata kg Loading capacity kg Traglast kg	Lunghezza mm Length mm Länge mm	Largh. interna mm Internal width mm Innenbreite mm	Largh. esterna mm External width mm Aussenbreite mm	Alt. montante mm Height of ramps' profile mm Tragerhöhe mm	Alt. bordo mm Height of raised side mm Randhöhe mm	Peso all'unità Kg Weight per piece kg Gewicht pro Stück kg
		A	B	C	D	E	
MPC1800.750.1000	1000	1800	690	750	70	23	23
MPC2000.750.1000	1000	2000	690	750	70	23	25
MPC2400.750.1000	1000	2400	690	750	80	23	30
MPC2600.750.1000	1000	2600	690	750	80	23	32
MPC3000.750.1000	1000	3000	690	750	100	23	37
MPC3600.750.1000	1000	3600	690	750	115	36	44
MPC1800.1000.1000	1000	1800	940	1000	70	23	34
MPC2000.1000.1000	1000	2000	940	1000	70	23	37
MPC2400.1000.1000	1000	2400	940	1000	80	23	45
MPC2600.1000.1000	1000	2600	940	1000	80	23	48
MPC3000.1000.1000	1000	3000	940	1000	100	23	55
MPC3600.1000.1000	1000	3600	940	1000	115	36	66
MPC4000.1000.1000	1000	4000	940	1000	125	36	78
MPC4400.1000.1000	1000	4400	940	1000	125	36	85
MPC5000.1000.1000	1000	5000	940	1000	140	32	99

Gamma disponibile CON o SENZA BORDO. Range available both WITH or WITHOUT EDGES. Rampenserie MIT oder OHNE RAND verfügbar.

SKIP RAMPS
MISTRAMPEN

pedane M070P

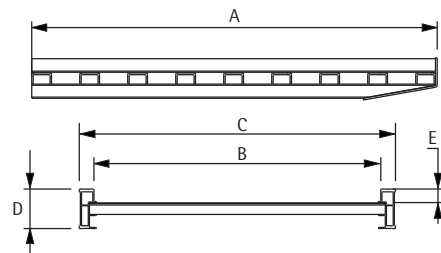

Codice articolo Item code Produktcode	Portata kg Loading capacity kg Traglast kg	Lunghezza mm Length mm Länge mm	Largh. interna mm Internal width mm Innenbreite mm	Largh. esterna mm External width mm Aussenbreite mm	Alt. montante mm Height of ramps' profile mm Tragerhöhe mm	Alt. bordo mm Height of raised side mm Randhöhe mm	Peso all'unità Kg Weight per piece kg Gewicht pro Stück kg
		A	B	C	D	E	
M070P/30	300	3000	500	560	70	23	18
M070P/40	300	4000	500	560	70	23	24
M070P/50	300	5000	500	560	70	23	30
M070P/58	300	5820	500	560	70	23	36

rampe SH

SH SHORT RAMPS
SH RAMPEN

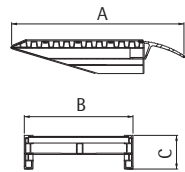
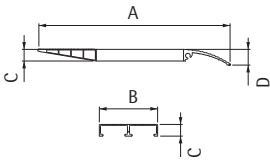

Codice articolo Item code Produktcode	Portata alla coppia kg Loading capacity per pair kg Traglast pro Paar kg	Lunghezza mm Length mm Länge mm	Largh. esterna mm External width mm Aussenbreite mm	Alt. montante mm Height of ramps' profile mm Tragerhöhe mm	Ingombro rampa in altezza mm Total height of ramp mm Laderampenhöhe mm	Dislivello superabile min-max mm Minimal-maximal loading height mm Minimale-maximale Ladehöhe mm		Peso alla coppia Kg Weight/pair kg Gewicht/Paar kg
		A	B	C	D	Min	Max	
M040B2/05SHF	1250	500	215	40	55	120	140	6
M040B2/08SHF	1250	800	215	40	55	160	180	8
M040B3/05SHF	2000	500	315	40	55	120	140	8
M040B3/08SHF	2000	800	315	40	55	160	180	12
M080/05SH	3000	506	300	80	80	120	140	10
M080/08SH	3000	810	300	80	80	160	180	13
M140/10SH	7500	1.000	500	140	140	170	190	34
M150/12SH	7500	1256	500	150	150	220	250	41
M150/15SH	7500	1500	500	150	150	270	300	48
M150/17SH	7500	1760	500	150	150	320	350	56
M165/20SH	7500	2000	500	165	165	370	400	69

Gamma disponibile solo SENZA BORDO.
Range only available WITHOUT EDGES.
Rampenserie nur OHNE RAND verfügbar.

rampe speciali

SPECIAL RAMP
SONDERRAMPEN

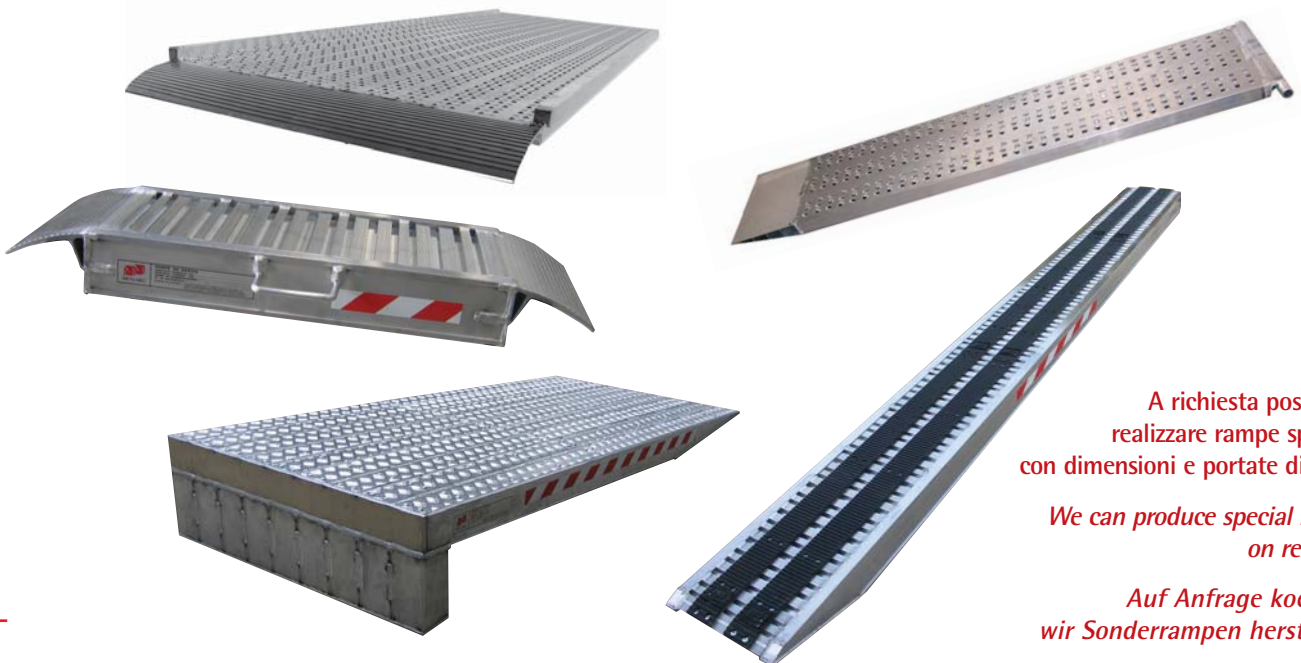

A richiesta possiamo realizzare rampe speciali con dimensioni e portate diverse.

We can produce special ramps on request.

Auf Anfrage koennen wir Sonderrampen herstellen.

accessori-opzioni



Striscie in gomma più acciaio per cingoli in ferro o rulli compattatori
Rubber strips+ steel for iron tracked vehicles or road rollers
Streifen aus Gummi+Stahl für eiserne Raupen oder Verdichtungswalzen

M070 M115A M165 M230
M075 M125 M170 M120S
M080 M140 M185
M100 M150 M200



Striscie in lamiera mandorlata
Quintet sheet covering
Streifen aus Quintettblech-Beschichtung

M120S



Staffa universale in acciaio
All-purpose steel bracket
Universal-Stahl-Buegel

M140
M150



Linguetta in alluminio
Aluminium bracket
Alu-Buegel

M030 M0100
M040 M115A
M070 M125
M075
M080



Staffa in acciaio con sistema di aggancio per la serie:
M140 - M150
Steel fixing bracket with anchoring system for series: M140 - M150
Versicherungssystem für die Serien: **M140 - M150**

Su richiesta può essere montata su altri modelli con sovrapprezzo. Also possible on request for other series with extra price. Auf Anfrage möglich auch auf andere Modelle mit Mehrpreis.



Grillo con catena per serie:
Fastening chain for:
Karabinerhaken mit Kette für:

M120S M185
M165 M200
M170 M230



A scelta: fissaggio con perno
At your choice: fixing by pin
Zur Auswahl: Bolzen

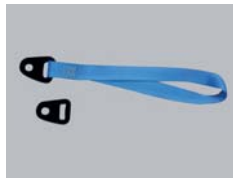

A scelta: maniglia in nylon
At your choice: textile handle
Zur Auswahl: Textilhandgriff

testate-appoggi

Diversi tipi di testate disponibili. Per eventuali sovrapprezzi riferirsi al listino in corso.
Different types of head connections are available. For any extra charge, please refer to the price list in force.
Verschiedene Auflageköpfe sind verfügbar. Für jeden Aufpreis, bitte Bezug auf geltenden Preisliste nehmen.



Testata con uncino
Head with hook
Hakenkopf



Testata con tubo
Head with tube
Endkopf mit Rohr



Testata standard
Head standard
Standardkopf



Testata con appoggio
Head with support
Endkopf mit Lager

Le rampe vengono realizzate con la Testata Standard se non diversamente richiesto dal cliente.
The ramps are manufactured with the standard head connection unless the customer chooses a different one.
Die Rampen werden mit der Standard Auflage hergestellt, wenn der Kunde keine andere Angabe gibt.

norme di sicurezza rampe di carico - note

SAFETY STANDARDS ALUMINIUM RAMPS - REMARKS
SICHERHEITSRICHTLINIE AUFFAHRAMPEN - BEMERKUNGEN

Non si deve superare la pendenza massima del 30%=16,5°. Le rampe devono essere ancorate al piano di carico.
Do not exceed the maximum gradient of 30%=16,5°. The ramps must be anchored to the loading level.
Eine Steigung von 30%=16,5° darf nicht überschritten werden. Die Rampen müssen an der Ladeebene verankert werden.

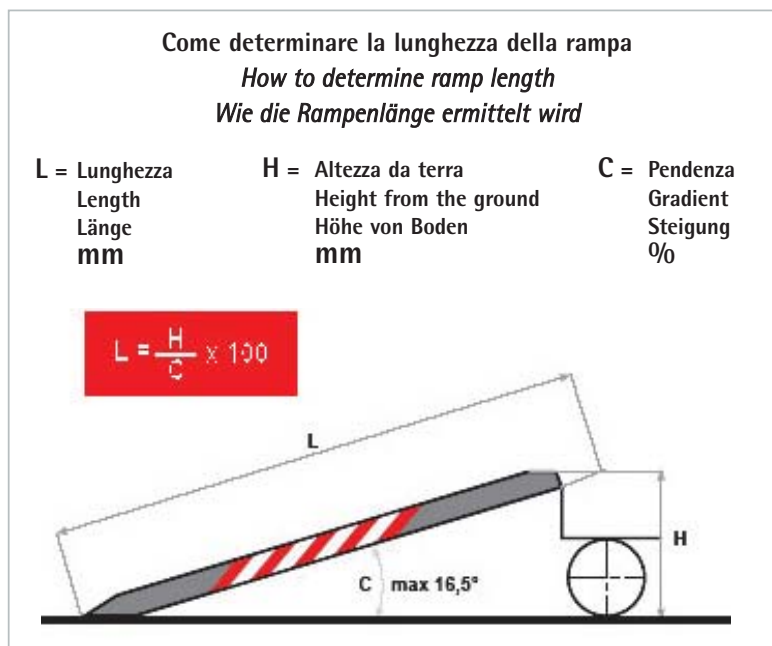

- 1 Le portate indicate si riferiscono a carichi uniformemente distribuiti a seconda dei passi indicati e della larghezza della rampa stessa.
The loading capacities we indicate refer to equally distributed weights according to the different wheelbases and to the ramps' width.
Die angegebenen Tragfähigkeiten beziehen sich auf gleichmassig verteilten Lasten, je nach den verschiedenen Achsenabständen und je nach der Rampenbreite.
- 2 Più si concentra il carico, più diminuisce la portata.
The higher the concentration of the load, the lower is the loading capacity of the ramps.
Je höher das konzentriertes Gewicht, desto niedriger ist die Tragfähigkeit der Rampen.
- 3 Attenersi anche alla larghezza minima indicata dell'impronta del cingolo o della ruota.
Please observe the minimum width of track/wheel indicated.
Bitte beachten Sie auch die angegebene Reifen / Raupen-Mindestbreite.
- 4 Tutte le nostre rampe dal modello M070 al modello M230 possono essere fornite con o senza bordo.
All ramps from series M070 till M230 can be produce with or without raised edges.
Alle Rampen ab Serie M070 bis M230 können mit oder ohne Rand hergestellt werden.
- 5 Nel caso in cui si voglia acquistare una coppia di rampe più lunga rispetto alla lunghezza minima ottenuta secondo la formula di calcolo citata nelle Norme di Sicurezza, si prega di segnalarlo in quanto la coda delle rampe dovrà essere adattata al nuovo angolo.
In case you would like to buy ramps which are longer than the calculated minimal length according to the formula mentioned in the Safety Standards, we kindly ask you to inform us as the foot end of the ramps will have to fit the new angle.
Wenn Sie Rampen kaufen möchten, die aber länger als die minimale Länge laut die Kalkulation bei der Sicherheitslinien sind, bitte melden Sie sich bei uns, da die untere Auflage an dem neuen Winkel angepaßt werden muss.
- 6 Per ordini di rampe senza bordo, aggiungere "S" alla fine del codice (es. M100/30S).
If you need ramps without raised edges, please add a „S“ to the end of the item code when ordering (i.e. M100/30S)
Bei Bestellungen für Rampen ohne Rand bitte schreiben Sie eine „S“ am Ende der RampenKode dazu (z.B. M100/30S)
- 7 I dati relativi alle lunghezze sono indicativi.
Per esigenze di lunghezze tassative Vi preghiamo di contattarci.
Generalmente, con le testate G-T-A, le rampe si accorciano.
The lengths we indicate are provisional.

Should a binding specific length be needed, please contact us.

The ramps shorten in length by mounting head connections G-T-A.

Die angegebene Länge sind anzeigend. Falls Sie besondere verbindliche Länge brauchen, bitte uns kontaktieren. Die Rampen mit Auflageköpfe G-T-A sich verkürzen.

- 8 Per tutte le norme d'uso e manutenzione attenersi alle indicazioni contenute nel manuale delle norme di utilizzo.

For all other use instructions please refer to the indications contained in our user guide.

Für alle anderen Gebrauchsanweisungen halten Sie sich bitte an die Vorrichtungen, die in unserer Anleitung enthalten sind.

- 9 Il produttore non è responsabile di eventuali danni a persone o cose che derivino da un improprio utilizzo delle rampe e/o passerelle o da inosservanza totale o parziale delle avvertenze indicate nei rispettivi manuali di utilizzo. Il produttore non risponde inoltre per danni o anomalie derivanti dalla mancanza di periodici controlli e manutenzioni.

The manufacturer doesn't respond for any damage to persons or things as a result of the incorrect use of the ramps/gangways or depending on the total or partial non compliance with the use instructions contained in their own guide. The manufacturer doesn't respond for any damage depending on lack of periodic inspection and maintenance.

Der Hersteller lehnt jede Verantwortung bei Missachtung der Gebrauchsanweisungen und bei unsachmassigem Gebrauch der Rampen oder Ladebrücke ab.

- 10 Per mezzi cingolati ferro è indispensabile utilizzare rampe con almeno il 15% di portata in più rispetto al peso del mezzo stesso.

For steel-tracked vehicles ramps with a loading capacity of 15% higher than the vehicles' weight are needed.

Für Stahlketten-Fahrzeugen müssen Rampen mit einer Tragkraft von 15% höher als das Fahrzeug Gewicht verwendet werden.

- 11 La casa costruttrice, nell'ambito del continuo miglioramento del prodotto, si riserva il diritto di apportare in qualsiasi momento, senza preavviso, modifiche alle caratteristiche tecniche dei propri modelli e relativi accessori.

With a view to continually improving its products, the manufacturer reserves the right to alter the technical specifications of, and accessories for its products at anytime without prior notice.

Im Sinne der standigen Produktbesserung behalt sich der Hersteller das Recht vor, jederzeit und ohne vorherige Benachrichtigung Aenderungen an den technischen Eigenschaften und an den Zubehoren seiner Modelle vorzunehmen.

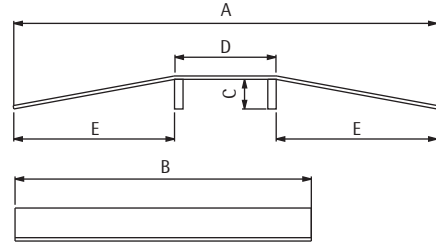
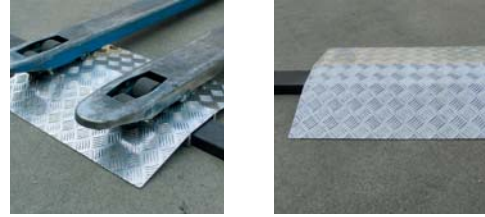

Codice articolo Item code Produktcode	Portata kg/m ² Loading capacity kg/m ² Tragfähigkeit kg/m ²	Lunghezza mm Length mm Länge mm	Larghezza mm Width mm Breite mm	Altezza mm Height mm Höhe mm	mm mm mm	mm mm mm	Peso Kg Weight kg Gewicht kg
		A	B	C	D	E	
MBAP1	450	490	700	40	120	185	4

Le misure possono essere variate a seconda delle esigenze di carico. Contattateci per maggiori informazioni.
All sizes can be customized, for more information please contact us.
Die Maßen dürfen nach Kundenwunsch geändert werden, bei Anfrage bitte melden.

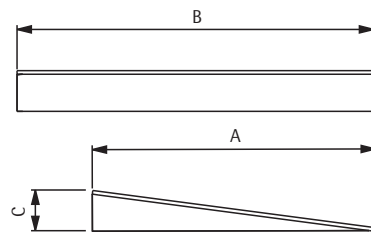
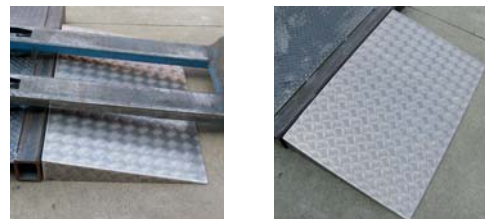

Codice articolo Item code Produktcode	Portata max kg Loading capacity max kg Tragfähigkeit max kg	Lunghezza mm Length mm Länge mm	Larghezza mm Width mm Breite mm	Altezza min-max mm Min-max height mm Min-max Höhe mm	Peso Kg Weight kg Gewicht kg
		A	B	C	
MBAC1	430	500	1000	10-70	10
MBAC2	430	650	1000	71-120	14
MBAC3	2920	500	1250	30-70	13
MBAC4	2920	800	1250	71-120	22

Le misure possono essere variate a seconda delle esigenze di carico. Contattateci per maggiori informazioni. Altezza C da specificare in fase di richiesta/ordine.
All sizes can be customized, for more information please contact us. Height C to be specified at offer request/order.
Die Maßen dürfen nach Kundenwunsch geändert werden, bei Anfrage bitte melden. Höhe C bitte bei Anfrage/Bestellung angeben.

MPL

PONTI DI CARICO AMOVIBILI
REMOVABLE LOADING BRIDGES
ÜBERLADEBRÜCKE

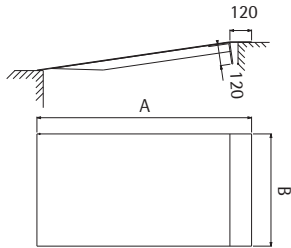

Codice articolo Item code Produktcode	Portata max kg Loading capacity max kg Tragfähigkeit max kg	Lunghezza mm Length mm Länge mm	Larghezza mm Width mm Breite mm	Dislivello min. mm Minimal loading height mm Minimale Ladehöhe mm	Dislivello max mm Max. loading height mm Max. Ladehöhe mm	Peso Kg Weight kg Gewicht kg
---	---	---------------------------------------	---------------------------------------	---	---	------------------------------------

		A	B			
MPL0750L	610	750	1250	0	+90	13
MPL1000L	610	1000	1250	+50	+120	17
MPL1200L	610	1200	1250	+60	+150	20
MPL1500L	610	1500	1250	+80	+190	25
MPL1800L	610	1800	1250	+100	+230	30
MPL0750H	1300	750	1250	0	+90	20
MPL1000H	1300	1000	1250	+50	+120	27
MPL1200H	1300	1200	1250	+60	+150	33
MPL1500H	1300	1500	1250	+80	+190	41
MPL1800H	1300	1800	1250	+100	+230	49

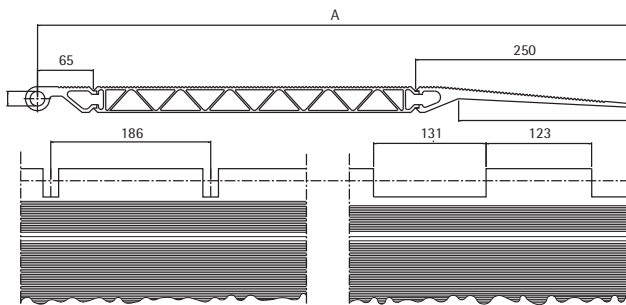
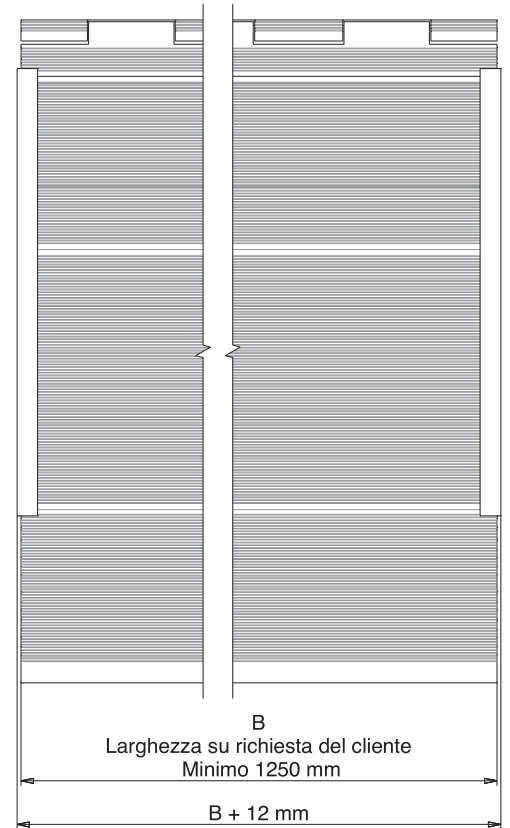
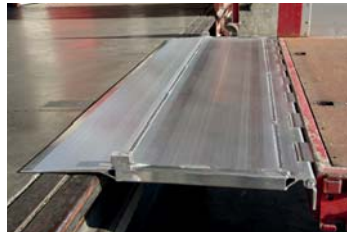

A scelta: / To choose from: / Zur Auswahl:



Incernieramento AC - acciaio
Hinge AC - steel
Anschluß AC - aus Stahl

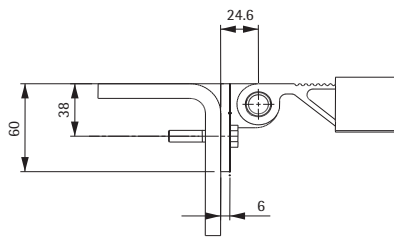
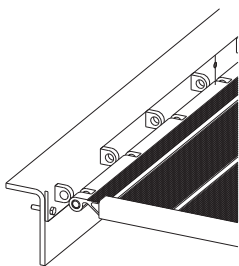

Incernieramento AL - alluminio
Hinge AL - aluminium
Anschluß AL - aus Aluminium

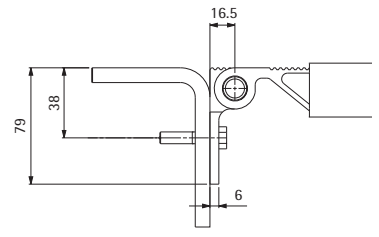
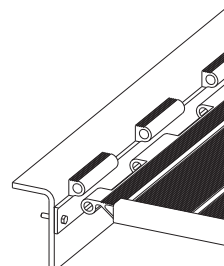

Codice articolo Item code Produktcode	Codice articolo Item code Produktcode	Lunghezza mm Length mm Länge mm	Larghezza mm (minimo 1250 mm) Width mm (min. 1250 mm) Breite mm (min. 1250 mm)	Portata max kg Loading capacity max kg Tragfähigkeit max kg	Peso Kg/m Weight Kg/m Gewicht Kg/m
MS030AC/565	MS030AL/565	565	<p>A partire da 1250 mm su richiesta</p> <p>From 1250 mm onward, on request</p> <p>Ab 1250 mm, auf Anfrage</p>	4170	19
MS030AC/690	MS030AL/690	690		3420	21
MS030AC/815	MS030AL/815	815		2890	25
MS030AC/940	MS030AL/940	940		2510	27
MS030AC/1065	MS030AL/1065	1065		2210	30
MS030AC/1190	MS030AL/1190	1190		1980	34
MS030AC/1315	MS030AL/1315	1315		1790	36
MS030AC/1565	MS030AL/1565	1565		1300	42
MS030AC/1690	MS030AL/1690	1690		1100	45
MS030AC/1815	MS030AL/1815	1815		950	48
MS030AC/2065	MS030AL/2065	2065		720	54

Larghezza B: considerare che il prodotto finito è sempre + 12 mm. Es: Larghezza B = 1250 mm / ingombro totale in larghezza = 1262 mm
Width B: please consider that the finished product is always + 12 mm. Ex.: Width B = 1250 mm / total width = 1262 mm.
Breite B: bitte beachten Sie, daß das Fertigprodukt immer + 12 mm sein wird. Z.B. : Breite B = 1250 mm / Gesamtbreite = 1262 mm.

MS030-2TL

PONTI DI CARICO AMOVIBILI TIPO 2TL
 REMOVABLE LOADING BRIDGES TYPE 2TL
 ÜBERLADEBRÜCKE TYP 2TL

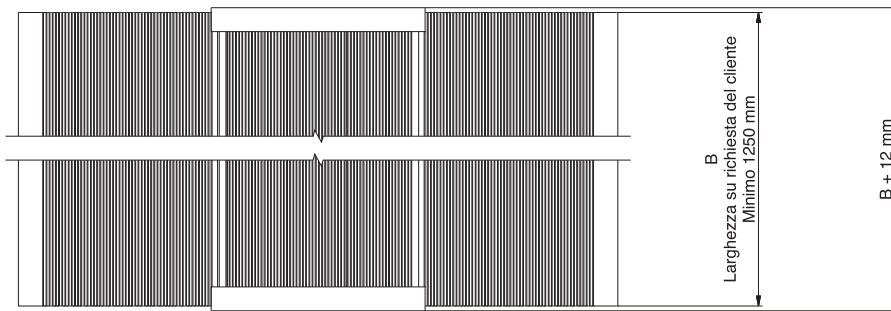
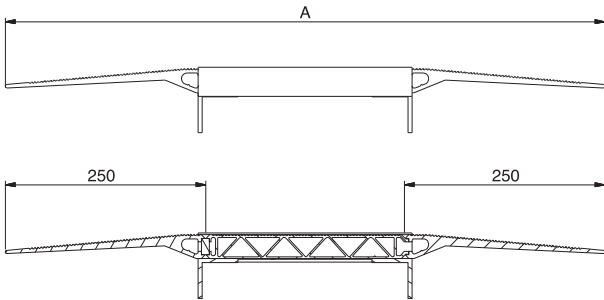

Codice articolo Item code Produktcode	Lunghezza mm Length mm Länge mm	Larghezza mm (minimo 1250 mm) Width mm (min. 1250 mm) Breite mm (min. 1250 mm)	Dislivello min. mm Minimal loading height mm Minimale Ladehöhe mm	Dislivello max. mm Max. loading height mm Max. Ladehöhe mm	Portata kg Loading capacity kg Tragfähigkeit kg	Peso Kg/m Weight kg/m Gewicht kg/m
	A	B				
MS0302TL/625	627	A partire da 1250 mm su richiesta From 1250 mm onward, on request Ab 1250 mm, auf Anfrage	-30	+30	3420	17
MS0302TL/750	752		-40	+40	2895	19
MS0302TL/875	877		-45	+45	2510	22
MS0302TL/1000	1002		-50	+50	2210	25

Larghezza B: considerare che il prodotto finito è sempre + 12 mm. Es: Larghezza B = 1250 mm / ingombro totale in larghezza = 1262 mm

Width B: please consider that the finished product is always + 12 mm. Ex.: Width B = 1250 mm / total width = 1262 mm.

Breite B: bitte beachten Sie, daß das Fertigprodukt immer + 12 mm sein wird. Z.B. : Breite B = 1250 mm / Gesamtbreite = 1262 mm

SERIE MBAP – MBAC – MPL – MS030 – MS030 2TL

I ponti con larghezza fino a 1,25 m sono stati progettati per resistere a carichi derivanti solo da traffico pedonale e carrelli industriali azionati da conducente a piedi.

Il dislivello tra i due piani non può superare la pendenza massima del 12,5% (circa 7°).

Al fine di rendere disponibile una larghezza di sicurezza minima su ciascun lato del mezzo di trasporto, la larghezza del ponte deve essere almeno 0,70 m maggiore della carreggiata di transito /trasporto, e in ogni caso non inferiore a 1,25 m .

Per maggior tutela degli operatori è consigliabile adottare una larghezza del ponte pari a quella della superficie di carico del veicolo.

Le estremità di appoggio, "testate", devono appoggiare sulla banchina di carico/scarico e sul pianale del veicolo, quando non incernierate sul medesimo, per almeno 0,10 m.

Per tutte le altre norme d'uso e di utilizzo attenersi alle indicazioni contenute nel manuale delle norme di utilizzo .

RANGES MBAP – MBAC – MPL – MS030 – MS030 2TL

Bridges less or equal to 1.25 m in width are designed to bear the weight of pedestrians or of self-propelled trailers manually operated by personnel on foot.

Levelling between planes cannot exceed 12,5% slope (7 degrees approx.)

In order to allow for a minimum safe width, bridge's width should be at least 0.70 m larger than transport carriageway or load width and, in any case, no less than 1.25 m.

For maximum workers' protection bridge width should equal transport vehicle load surface width.

Bridge's support edges (a.k.a. "headboards"), when not directly hinged, must rest against load platform and transport vehicle deck for at least 0.10 m.

For all other use instruction please refer to the indications contained in our user guide.

SERIEN MBAP – MBAC – MPL – MS030 – MS030 2TL

Die Brücken mit Breite bis zu 1,25 m sind geplant worden, um Lasten zu vertragen, die nur vom Fußgängerverkehr sowie von mitgängergeführten industriellen Staplern herrühren.

Der Höhenunterschied zwischen den zwei Ebenen darf die maximale Neigung von 12,5% (ungefähr 7°) nicht überschreiten

Zum Zwecke eine Mindestsicherheitsbreite auf jeder Seite des Transportmittels zur Verfügung zu stellen, muss die Brücke mindestens 0,70 m breiter als die Durchgangs/Transportfahrbahn sein, und jedenfalls nicht minder als 1,25 m .

Zum besseren Schutz der Bediener empfiehlt sich die Anwendung einer Brückenbreite, die der Ladefläche des Fahrzeuges entspricht.

Die Auflageenden, "Brückenköpfe", müssen auf dem Lade/Ausladeplatz und auf dem Flachboden des Fahrzeuges, falls sie auf demselben nicht aufklappbar sind, um mindestens 0,10 m aufliegen.

Für alle anderen Gebrauchsanweisungen halten Sie sich bitte an die Vorrichtungen, die in unserer Anleitung erhalten sind.





METALMEC SRL

Via S.Cassiano, 6

24030 Mapello (BG) Italy

Tel. +39 035 4945858

Fax +39 035 4945149

www.metalmecsr.com

info@metalmecsr.it

